



**KEN AND
JERRY'S
COMMEMORATIVE
WEDDING PROGRAM
AND COLORING BOOK!**

FRI, FEB 29, 2008

WELCOME!

WELCOME ONE AND ALL TO OUR WEDDING. WE'RE BOTH SO GLAD YOU COULD MAKE IT! WE HOPE YOU ENJOY THE EVENING WE HAVE IN STORE FOR YOU. THE SCHEDULE OF EVENTS IS ON THE BACK COVER.

DON'T WORRY IF YOU CAN'T SOLVE ALL OF THE PUZZLES - THE SOLUTIONS ARE UP ON KENANDJERRY.COM RIGHT NOW!

- KEN & JERRY



Ken and Jerry Need to get outa town Quick, Fast, and in a Hurry! Help them find the quickest route to the airport!

...and don't hit any insults either!

Meathead!

What a Zero!

Geek!

Loser!

Oh, Get Real!

Bonehead!

Butthead!

Oh You're such a Schmuck!

No Way!

Dork!

Dummy!

Phlegmhead!

How did you get here?

Oh, Do You Suck!

San Jose Airport!

The Barrios of East San Jose!

San Francisco's Castro Street

Lopez, 2007

THE KEN & JERRY STORY



THIS WAS THE NIGHT KEN & JERRY MET AT CINEMA SAN PEDRO. BUT THEY DIDN'T REALLY MEET THAT NIGHT...



THEY REALLY MET BECAUSE OF A TV SHOW...



PRETTY SOON, JERRY WAS ENTICING HIM WITH CHEESECAKE PHOTOS...



AND SOON AFTER, THEY WERE ALWAYS DOING WEIRD STUFF TOGETHER...



LIKE HARRY POTTER AND PIRATE PARTIES.



PRETTY SOON, HE WAS LEAVING HIS STUFF ALL OVER HER HOUSE.



LONDON!

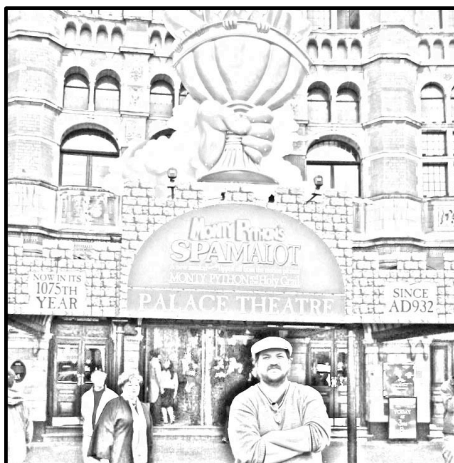



We're forever blowing bubbles!

Here is a POP quiz customized just for Ken & Jerry! By bursting one bubble at a time, it is possible to reduce this nine-letter word to a one-letter word. Each time a bubble is burst, the remaining letters, in order, will spell a common word. Can you show how it's done? Do not use proper names or abbreviations.

S P A R K L I N G

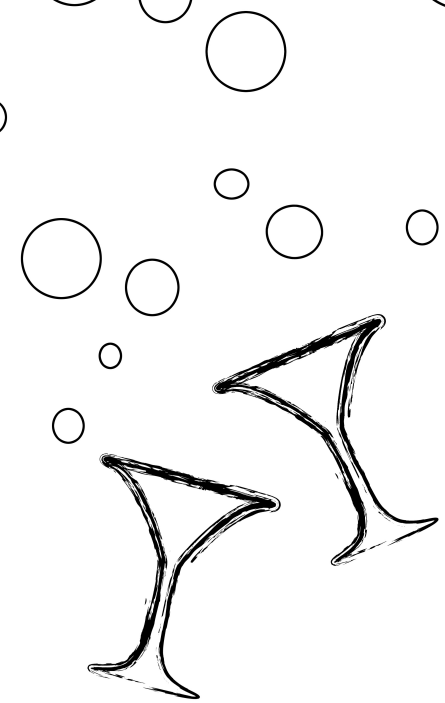

This game was lifted from Brain Games 2. My apologies to Will Shortz. Answers are on page

SOLUTION ON KENANDJERRY.COM!

FILL IN THE BLANKS!

“The goal in marriage is

_____ ,
_____”

— Robert C. Dodds

k _____ ted
hyp _____ ic
_____ ebook

sui _____ r
as _____ nish
_____ ken

betro _____ ed
toge _____ er
fai _____ ful

tr _____ et
_____ ling

cuffl _____

appe _____ ng
v _____ date
mamm _____ an

as _____ d
ca _____
_____ y

attri _____ e
_____ ton
re _____ tal

car _____ on
momen _____ us
pho _____ grapher

soo _____ ng
e _____ cs
my _____ cal

dri _____
tha _____ ful
u _____ nown

accus _____ med
u _____ pia
plu _____ nium

tar _____
ener _____ ic
_____ away

c _____ ish
gat _____ ing
us _____



The Beatles fly to America.

SOLUTION ON KENANDJERRY.COM!

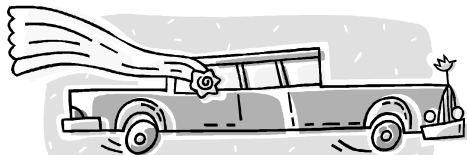

Ken & Jerry @ Dann & Mo's...A Hidden Picture Adventure!

Another Spookfest Friday find Ken & Jerry at Dann & Mo's house for cheesy movie goodness. Find all the stuff stuffed into the picture. Some are hidden and some are right out there in plain sight. See if you can find them all!

Things to Find:

- Elephant
- Gooney Bird
- Crocodile
- Pig
- Magician's Top Hat
- Baseball
- Baseball Bat
- Mini Cooper
- Thunderbird
- Tardis
- Leaf
- Gecko
- Apple
- Grapes
- Creature from the Haunted Sea

How many?

- Dinosaurs _____
- Cats _____
- Spiders _____
- Rockets _____
- Skulls _____
- Fish _____



SOLUTION ON KENANDJERRY.COM!

OW

NO!

NOW, CONNECT THE DOTS TO HELP THEM ESCAPE!

KEN AND JERRY ARE UNDER ATTACK!

YOU CAN HELP FIND OUT WHAT'S ATTACKING THEM!
CONNECT THE DOTS - FAST!

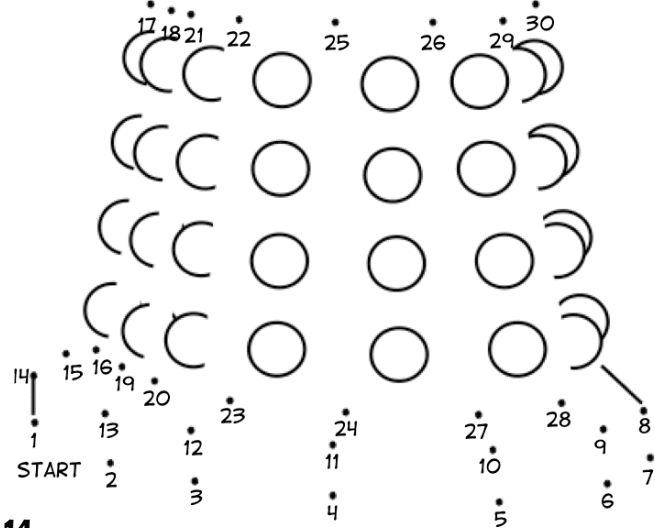
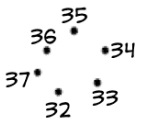
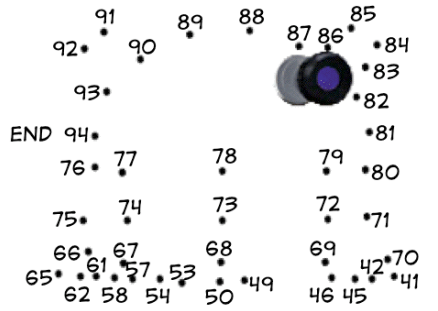

WHERE WAS KEN PARKED NOW?



Where

Ken

&

Jerry

Almost

Met

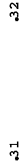
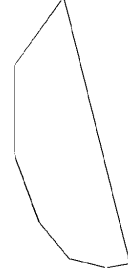
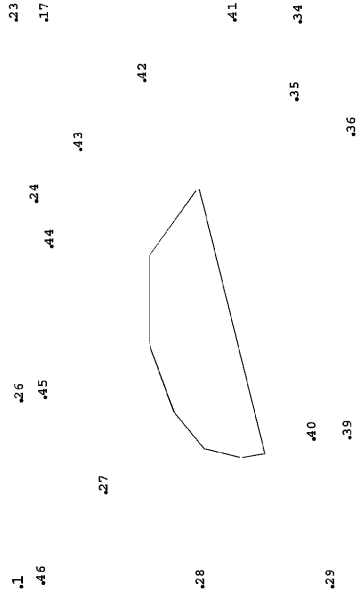
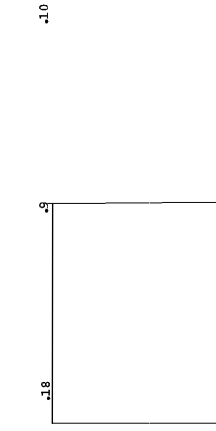
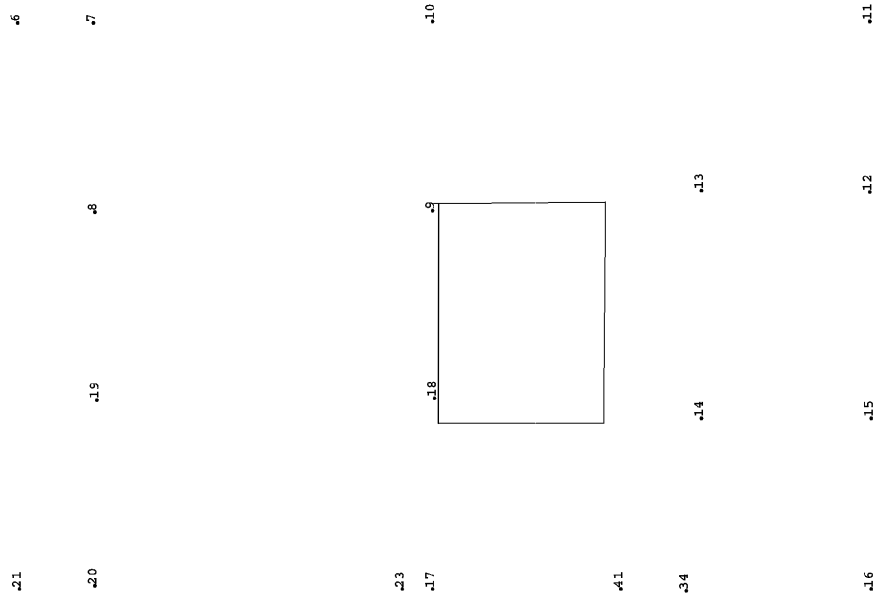

"LOST IN LOVE"

Help Ken and Jerry find their wedding clothes!

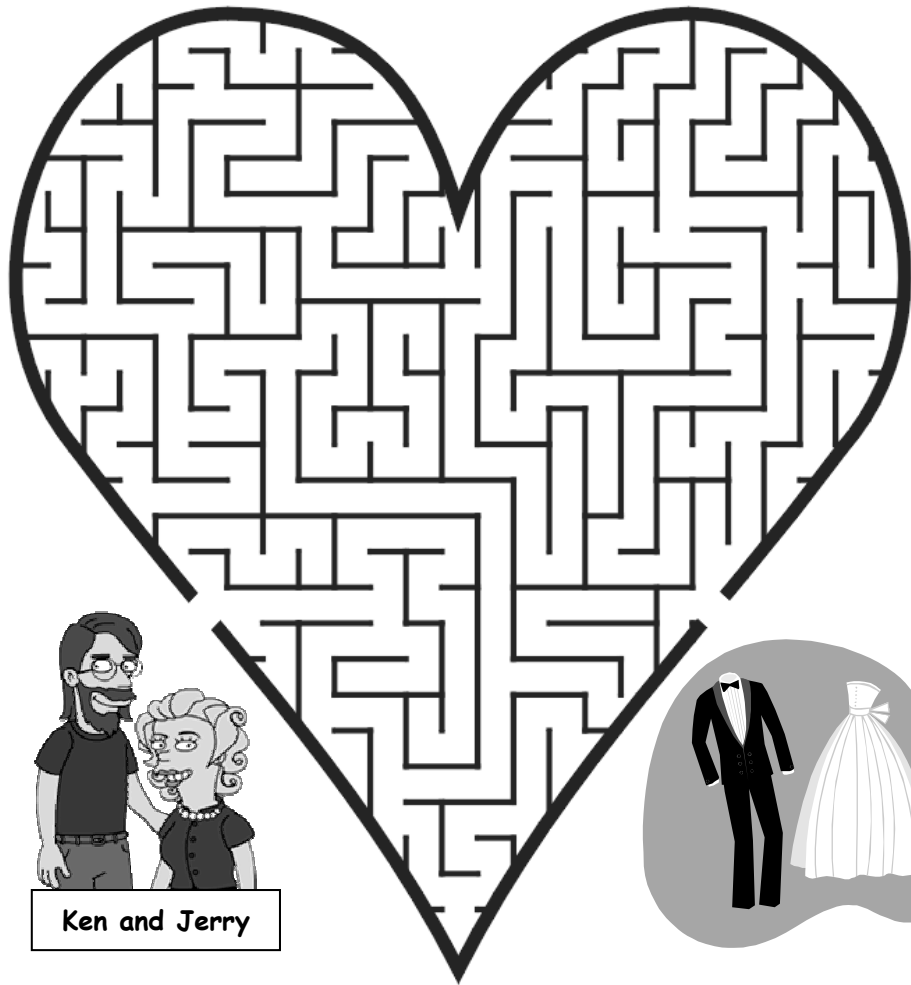

Ken and Jerry

Dog, Cat, Mouse!

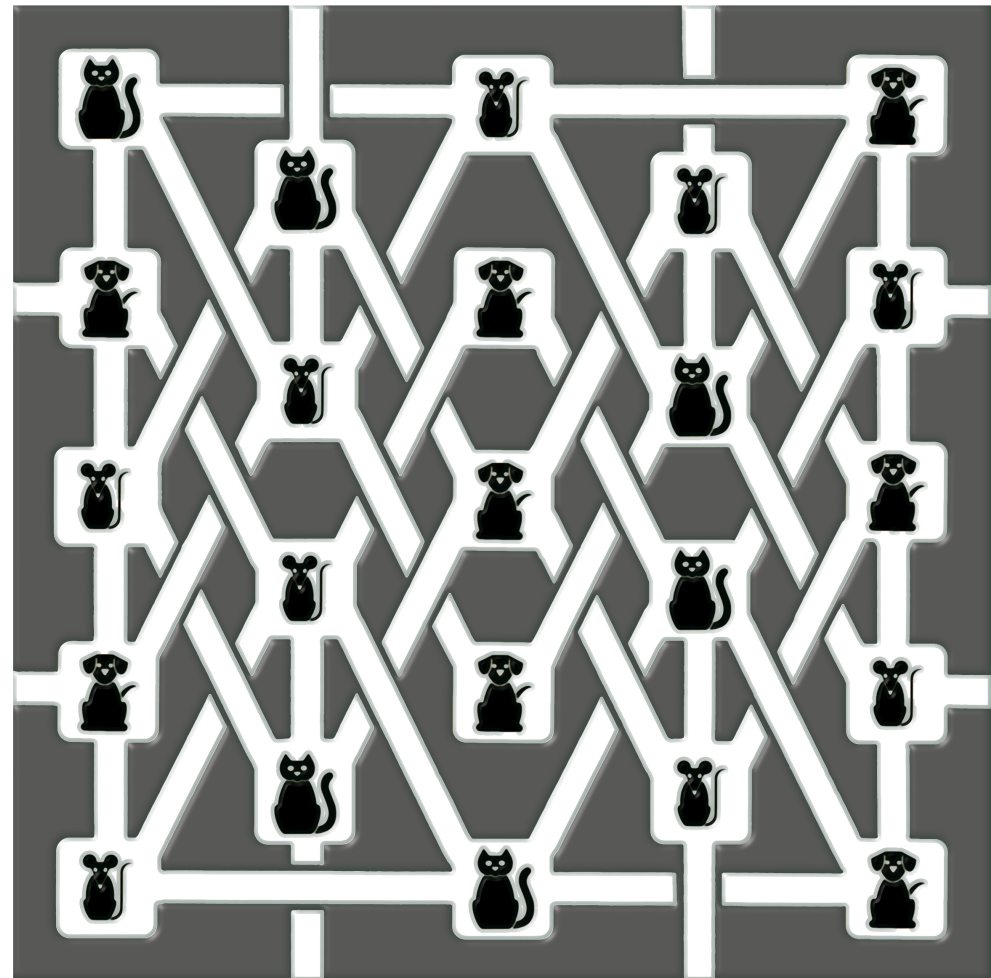

Help Ken and Jerry round up all the stray pets!

- OBJECTIVES: Enter maze and collect all dogs, cats and mice. Exit!
- RESTRICTIONS: You may not enter a cat space from a mouse space.
You may not enter a dog space from a cat space.
Paths pass over and under each other
You may not enter any space or use any path more than once.

SOLUTION ON KENANDJERRY.COM!

More Than Words

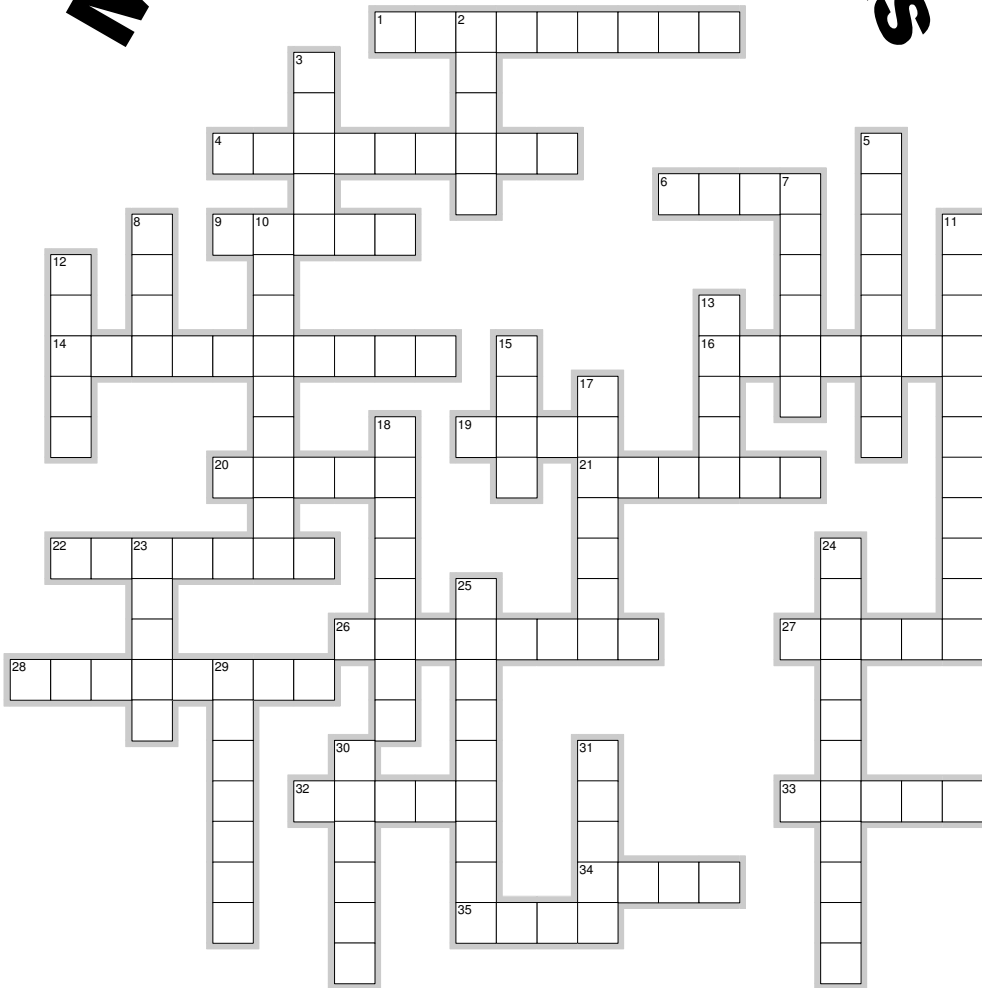

Across

1. A man's jewelry (2 words)
4. "___ in Vegas"
6. Solemn public promises
9. Adorns the bride
14. "A Very Long ___"
16. A man who always consults his better half instead of his better judgment.
19. A woman who has found the perfect man and now wants to improve him.
20. Walk down the ___
21. Force per unit area which may cause strain on a body
22. May not spread infection, but it sure lowers a girl's resistance.
26. A caress set to music (2 words)
27. Run away! Run away!
28. A device which may help a marriage--as long as the couple do not drift apart.
32. The one sure way to make a marriage last.
33. A stable man
34. The financial result of many weddings
35. When you think of someone else almost as much as you do of yourself.

Down

2. "Mr. Corleone never asks a second ___ once he's refused the first, understood?"
3. "All she wants to do is ___"
5. "A very good way to promote civilization--if you get a good wife, you will be happy; if you get a bad one, you will become a philosopher."
- *Socrates*
7. A husband or wife
8. A metal donut. Mmm... donut...
10. A great opportunity to raise a toast
11. Tired (2 words)
12. Invitee
13. Never wear after Labor Day
15. Headpiece
17. Responsible for making sure the groom gets to the wedding (2 words)
18. A song written by Joy Division and recorded by New Order
23. Dyed to match
24. Handwriting for expensive wedding invitations
25. ___ dinner
29. Throw the ___
30. Goes well with a vodka martini--shaken, not stirred
31. "Here Comes the ___"

SOLUTION ON KENANDJERRY.COM!

COLORING CONTEST

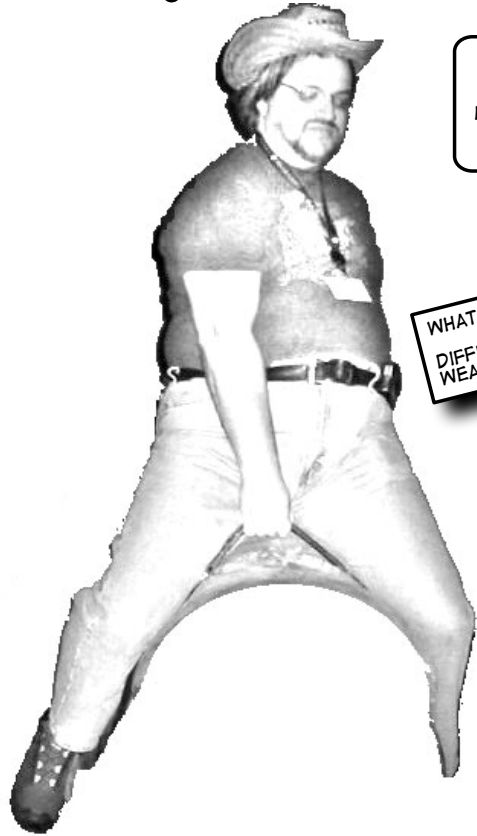

HERE'S THE ORIGINAL PICTURE OF KEN RIDING A MECHANICAL BULL!

WHAT IS KEN RIDING NOW?
DIFFICULTY: NO NUCLEAR WEAPONS



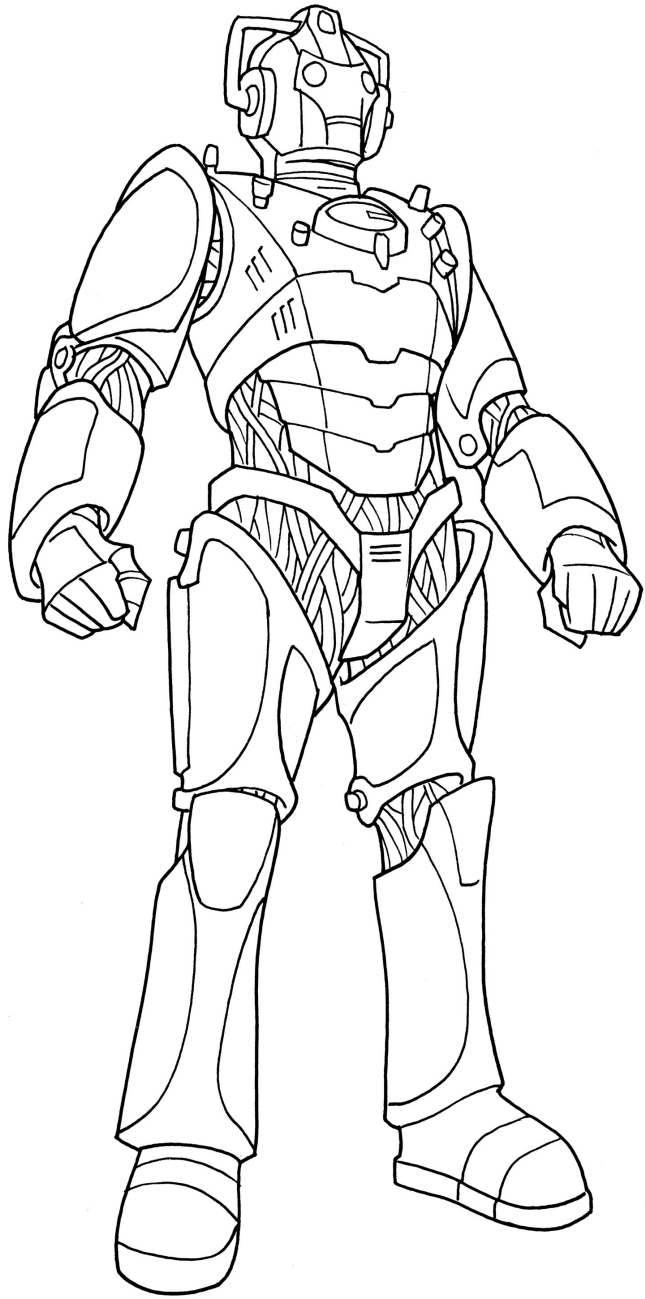

CREDITS



ARTISTS

DANN LOPEZ (3)

MO STARKEY (9, 12-13, 19)

CURTIS CHEN & DEEANN SOLE (10, 17, 18, 20-21)

TV'S MISTER LOBO (23, 24, 26)

JERRY MAJORS (4-8, 14-15, 16, 22)

STAFF

DEEANN SOLE

CURTIS CHEN

MERV STATON

JUDITH RICHARDSON

KEVIN ROCHE

ANDY TREMBLEY

LINDA WENZELBURGER

MARTHA PATTERSON

CRISSY GUGLER

MIKE QUEBEC

OFFICIANT

CHRIS "FOR TAFF" GARCIA

All trademarks are the property of their respective owners.

PROGRAM

5:30	RECEPTION
6:15	FILM STARTS
AFTER THAT	CEREMONY
FOLLOWING	DINNER!
SOMETIME	SWING DANCE LESSON
	WITH DANCE INSTRUCTOR MIKE QUEBEC
THEN	OPEN DANCING
LATER	CAKE!
10:00	DOORS CLOSE